

**Lateral Grooves**

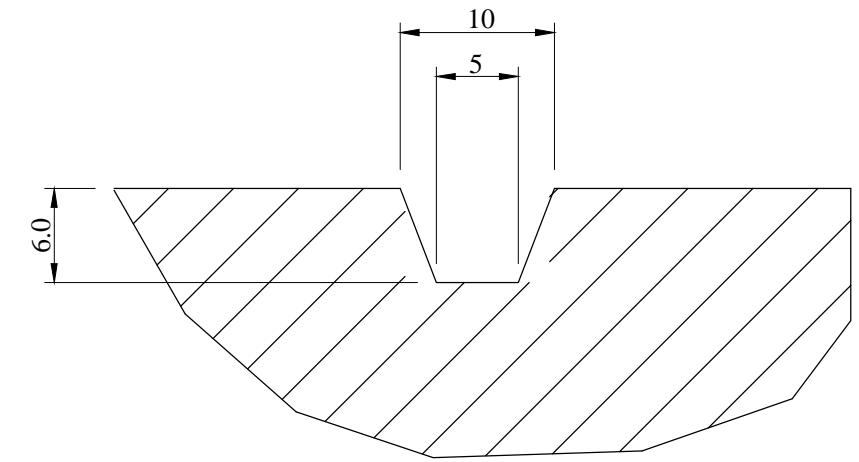

**Circumferential Grooves**

**AVON Tyres Racing**

Pattern Type

Universal Wet

Drawn:-  
08/04/04

Pattern No

M003

Drawn By:-  
NRU